

Loop spaces of the Q -construction

by

Amnon Neeman (Canberra, ACT)

Abstract. Giffen in [1], and Gillet–Grayson in [3], independently found a simplicial model for the loop space on Quillen’s Q -construction. Their proofs work for exact categories. Here we generalise the results to the K -theory of triangulated categories. The old proofs do not generalise. Our new proof, aside from giving the generalised result, can also be viewed as an amusing new proof of the old theorems of Giffen and Gillet–Grayson.

0. Introduction. In [4], following Quillen, Grayson gives a construction of a loop space for the Q -construction. It is the so-called $S^{-1}S$ -construction. This recipe only works for split exact categories. In [4], it is used to prove that the $+$ -construction and the Q -construction give the same K -theory.

Finding a model for the loop space of $Q(\mathcal{E})$ for an arbitrary exact category \mathcal{E} proved quite difficult. The problem took some 10 years to solve, and independent solutions were given by Giffen [1] and Gillet–Grayson [3]. The arguments in both articles are difficult, and at points quite ingenious.

The main result of this article is that both the theorem of Giffen and the theorem of Gillet–Grayson generalise to the K -theory of triangulated categories. This K -theory is defined and discussed in [7]–[11].

The reader should note that the generalisation is not trivial. The proofs of Giffen and Gillet–Grayson do not generalise. What we do here is find new proofs of the old theorems of Giffen and Gillet–Grayson. It is these new proofs that do generalise to the triangulated setting. So an amusing sideline of this article is that we provide new proofs for the old theorems. In fact, the article is written to underline this fact. From an expository point of view, I wrote it to illustrate how the techniques of triangulated K -theory can be used to give new proofs of well-known facts.

At the referee’s suggestion, this article was made fairly independent of [7]–[11]. This means that if the reader does not care about triangulated K -theory, and only wants to see an entertaining new proof of the theorems

2000 *Mathematics Subject Classification*: 18F25, 18E30, 19D99.

of Gillet–Grayson and Giffen, then we introduce enough of the homotopy theoretic machinery to make this article almost self-contained. The one notable exception is that we do not prove Theorem I.3.7 of [7], but we do use it. Given the discussion we present of our simplicial techniques, the reader should be able to easily provide his own proof. There is a general summary of the techniques of [7]–[11] in Section 1; in particular, the statement (but not proof) of Theorem I.3.7 is presented. Then in Section 2 we give a very detailed proof of Theorem 2.3 (the theorem of Gillet–Grayson). That is, we give the proof both in terms of the shorthand notation of [7]–[11], and very explicitly, writing out what each map and homotopy does to a typical cell in the simplicial set. After that we assume that the reader has acquired sufficient familiarity with the shorthand, so we can use it without any further comment.

In Section 3, we prove Giffen’s theorem. In each case we give a very complete and self-contained proof.

1. A brief review of the notation of triangulated K -theory. It seems fair to begin with a review of the notation of [7]–[11]. I will assume that the reader who needs the review is not particularly interested in triangulated K -theory; thus in this section \mathcal{T} will always be an *exact* category.

One model of Quillen’s K -theory of the exact category \mathcal{T} is the bisimplicial set $\boxed{\begin{array}{c} \uparrow \\ \mathcal{T} \end{array}}$. An (m, n) -simplex is a diagram of bicartesian squares

$$\begin{array}{ccc} X_{m0} & \xrightarrow{\quad} & \cdots & \xrightarrow{\quad} & X_{mn} \\ \uparrow & & & & \uparrow \\ \vdots & & & & \vdots \\ \uparrow & & & & \uparrow \\ X_{00} & \xrightarrow{\quad} & \cdots & \xrightarrow{\quad} & X_{0n} \end{array}$$

The vertical maps are assumed admissible epis, the horizontal maps admissible monos. This is indicated by the arrow type of the map, both in the diagram above of a typical cell in the simplicial set, and in the shorthand

$$\boxed{\begin{array}{c} \uparrow \\ \mathcal{T} \end{array}}$$

for the simplicial set. The face maps on this bisimplicial set are given by deleting a row or a column in the array giving a simplex. The degeneracy maps are insertions of identities. To see that this is closely related to Quillen’s original definition, note that every object in the diagram is a subquotient of X_{0n} . Thus, a simplex can be thought of as giving an object X_{0n} and several subquotients. The fact that this simplicial set is homotopy

equivalent to Quillen's is most certainly not new. Waldhausen certainly knew it. It also appears, quite explicitly, in the work of Jardine; see [6].

The shorthand should be self-explanatory. For instance, the bisimplicial

set $\boxed{\begin{array}{c} \uparrow \\ \mathcal{T} \longrightarrow \end{array}}$ will have for its (m, n) -simplices diagrams of bicartesian squares

$$\begin{array}{ccc} X_{m0} & \longrightarrow & \cdots & \longrightarrow & X_{mn} \\ \uparrow & & & & \uparrow \\ \vdots & & & & \vdots \\ \uparrow & & & & \uparrow \\ X_{00} & \longrightarrow & \cdots & \longrightarrow & X_{0n} \end{array}$$

where now both the horizontal and the vertical maps are assumed epi. Thus

in the symbol $\boxed{\begin{array}{c} \uparrow \\ \mathcal{T} \longrightarrow \end{array}}$, the vertical arrow specifies the restriction on the vertical maps in the array, and the horizontal arrow specifies the restriction on the horizontal maps.

One of the early theorems in [7] is Theorem I.3.7. It states:

THEOREM I.3.7. *The natural inclusions induce homotopy equivalences among*

$$\boxed{\begin{array}{c} \uparrow \\ \mathcal{T} \longrightarrow \end{array}}, \quad \boxed{\begin{array}{c} \uparrow \\ \mathcal{T} \longrightarrow \end{array}}, \quad \boxed{\begin{array}{c} \uparrow \\ \mathcal{T} \longrightarrow \end{array}}, \quad \boxed{\begin{array}{c} \uparrow \\ \mathcal{T} \longrightarrow \end{array}}, \quad \boxed{\begin{array}{c} \uparrow \\ \mathcal{T} \longrightarrow \end{array}}, \quad \boxed{\begin{array}{c} \uparrow \\ \mathcal{T} \longrightarrow \end{array}}.$$

In the proof of Theorem I.3.7, and other results like it, we are naturally led to studying larger simplicial sets. There is a shorthand notation for them. One assembles them from parts like the above. Thus the trisimplicial set

$\boxed{\begin{array}{c} \uparrow \\ \mathcal{T} \longrightarrow \end{array}} \twoheadrightarrow \boxed{\begin{array}{c} \uparrow \\ \mathcal{T} \longrightarrow \end{array}}$ consists of (m, n, p) -simplices

$$\begin{array}{cccc} X_{p0} & \longrightarrow & \cdots & \longrightarrow & X_{pm} & \longrightarrow & Y_{p0} & \longrightarrow & \cdots & \longrightarrow & Y_{pn} \\ \uparrow & & & & \uparrow & & \uparrow & & & & \uparrow \\ \vdots & & & & \vdots & & \vdots & & & & \vdots \\ \uparrow & & & & \uparrow & & \uparrow & & & & \uparrow \\ X_{00} & \longrightarrow & \cdots & \longrightarrow & X_{0m} & \longrightarrow & Y_{00} & \longrightarrow & \cdots & \longrightarrow & Y_{0n} \end{array}$$

The idea of the shorthand is that we have attached a simplex in

$$\boxed{\begin{array}{c} \uparrow \\ \mathcal{T} \longrightarrow \end{array}}$$

(namely the X 's) to a simplex in $\begin{array}{c} \boxed{\uparrow} \\ \boxed{\xrightarrow{T}} \end{array}$ (namely the Y 's) by connecting

them with horizontal maps of the type indicated by the arrows joining the two boxes. All squares in the diagram are assumed bicartesian, in the strongest possible sense. That is, given a simplex, and inside it a square

$$\begin{array}{ccc} C & \longrightarrow & D \\ \uparrow & & \uparrow \\ A & \longrightarrow & B \end{array}$$

we assume that

$$A \twoheadrightarrow B \oplus C \twoheadrightarrow D$$

is a distinguished short exact sequence. In future, when we say “bicartesian square”, we will mean a strongly bicartesian one, as above. The vertical maps are assumed mono. The horizontal maps among X 's are mono, the horizontal maps among Y 's are epi, and the horizontal maps connecting X 's to Y 's are assumed epi.

In this type of homotopy theory, it is standard to consider projection maps. Thus we have a map

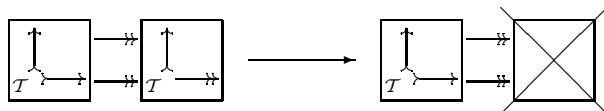

which takes the simplex

$$\begin{array}{ccccccc} X_{p0} & \twoheadrightarrow & \cdots & \twoheadrightarrow & X_{pm} & \twoheadrightarrow & Y_{p0} & \twoheadrightarrow & \cdots & \twoheadrightarrow & Y_{pn} \\ \uparrow & & & & \uparrow & & \uparrow & & & & \uparrow \\ \vdots & & & & \vdots & & \vdots & & & & \vdots \\ \uparrow & & & & \uparrow & & \uparrow & & & & \uparrow \\ X_{00} & \twoheadrightarrow & \cdots & \twoheadrightarrow & X_{0m} & \twoheadrightarrow & Y_{00} & \twoheadrightarrow & \cdots & \twoheadrightarrow & Y_{0n} \end{array}$$

and sends it to the simplex

$$\begin{array}{ccc} X_{p0} & \twoheadrightarrow & \cdots & \twoheadrightarrow & X_{pm} \\ \uparrow & & & & \uparrow \\ \vdots & & & & \vdots \\ \uparrow & & & & \uparrow \\ X_{00} & \twoheadrightarrow & \cdots & \twoheadrightarrow & X_{0m} \end{array}$$

that is, it is the map which simply forgets the Y 's. Again, the notation is meant to be suggestive; we cross out what is being forgotten. Proofs in this theory proceed by studying sequences of maps as above, and proving them to be homotopy equivalences.

To do this, one repeatedly makes use of Segal's theorem; it suffices to show that the map becomes a homotopy equivalence of simplicial spaces after realising some of the simplicial structures. For a proof, see Proposition A.1(ii) and (iv) on page 308 of [13]. Let us study a variant of the example above. We will prove that the map

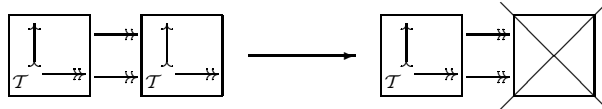

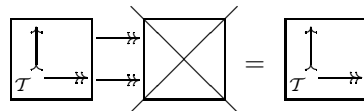

induces a homotopy equivalence. [The reader needs to be careful here. This is *not* identical with the example above. Note that the horizontal morphisms in the left-hand box are restricted to be admissible epi in the variant, restricted to be admissible mono in the original.] In the variant, we have a trisimplicial map of trisimplicial sets, if we declare one of the simplicial structures on



to be trivial. We need to show the map is a homotopy equivalence. It suffices to show that it is a homotopy equivalence after realising exactly one simplicial

structure. We will realise the one that becomes degenerate on .

Since it is degenerate on , the realisation of  is discrete. It

is simply the bisimplicial set  viewed as a bisimplicial space with the

discrete topology. To show that the map becomes a homotopy equivalence, it therefore suffices to show that the fiber over every point in this discrete bisimplicial set is contractible. We refer to this fiber as the *Segal fiber*.

In the example above, the Segal fiber of the map

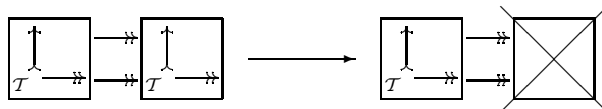

is the simplicial set of all diagrams

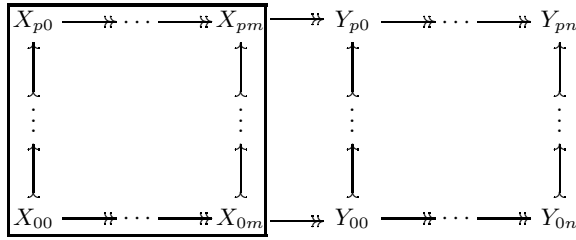

where the X 's are held fixed. The Y 's are allowed to vary; the projection forgets them. But the X 's are fixed, and in particular, the integers m and p are held fixed. Only the simplicial structure corresponding to changing the integer n is being realised.

This simplicial set, the Segal fiber, is denoted by $\boxed{X} \rightrightarrows \boxed{\begin{array}{c} \uparrow \\ \mathcal{T} \end{array}}$.

The letter with no superscript arrows is meant to denote that that part of the diagram is fixed. In the symbol for a typical simplex

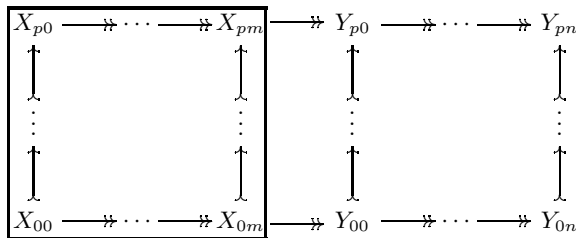

we denoted the same thing by framing the X 's.

Finally, to prove our map is a homotopy equivalence it suffices to establish

the contractibility of the Segal fiber $\boxed{X} \rightrightarrows \boxed{\begin{array}{c} \uparrow \\ \mathcal{T} \end{array}}$. To do this it suf-

fices to give a contracting homotopy. In this case, the homotopy is extremely easy to write down. A simplicial homotopy takes an n -simplex to a string of $n + 1$ different $(n + 1)$ -simplices. In the case above, we want the homotopy to take the simplex

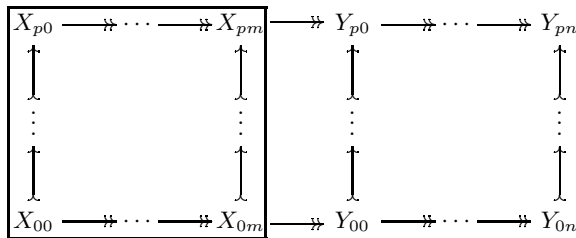

to the string of simplices

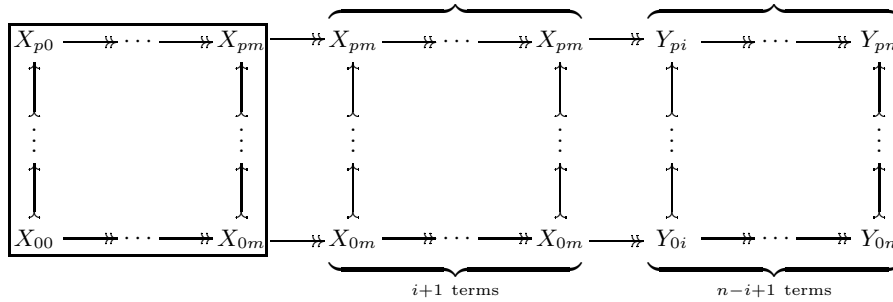

The shorthand for this homotopy is the symbol

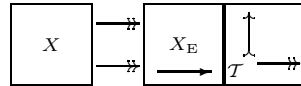

Once again, the notation is intended to be self-explanatory. The east face of the X 's (denoted by X_E) is moving to the right (indicated by the arrow underneath it), and ultimately sweeps out the Y 's to contract the simplicial set.

Up until now everything we have done has been nothing but notation, for homotopies which can be described just as easily using the language of functors and natural transformations. But there is in this theory one new homotopy, which somehow always ends up doing all the non-trivial work. To illustrate, let us now prove that the projection

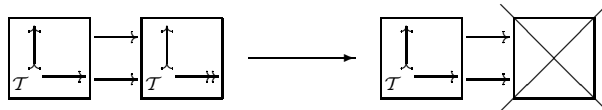

induces a homotopy equivalence. [Once again, note the restrictions on the horizontal morphisms. Bökstedt once told me that one needs good eyesight to read these papers. The restrictions on the arrows are essential.] Everything is formally as before. By Segal's theorem it suffices to prove that the map is a homotopy equivalence after realising only some of the simplicial structures. We realise only the one that is degenerate on the target; we are then reduced to proving the contractibility of the Segal fiber

$X \rightarrow \mathcal{T}$. A simplex in this fiber is a diagram

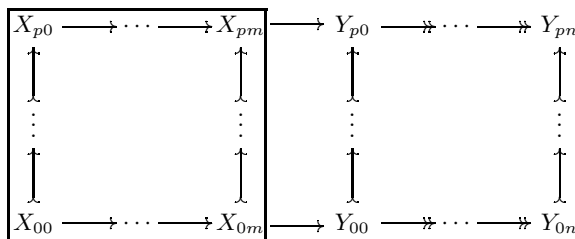

and the only real difference from the above is that some horizontal morphisms are free; they are not assumed either epi or mono. Precisely, the horizontal morphisms connecting the X 's among themselves, and the horizontal morphisms connecting the X 's to Y 's are unrestricted.

The homotopy whose symbol might be

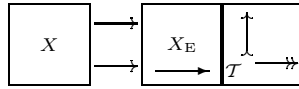

decidedly does not work. It is not a homotopy. A typical cell would be

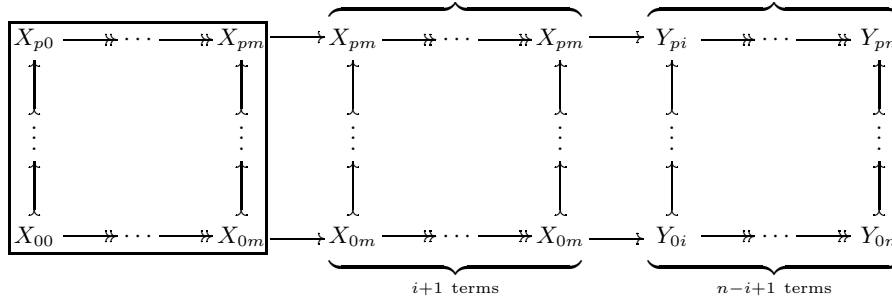

but the horizontal maps connecting the X 's and Y 's are not necessarily epi. A typical cell of this fake “homotopy” does not lie in the simplicial set. The morphisms do not satisfy the assumed restrictions.

Consider instead the homotopy whose typical cell is the diagram

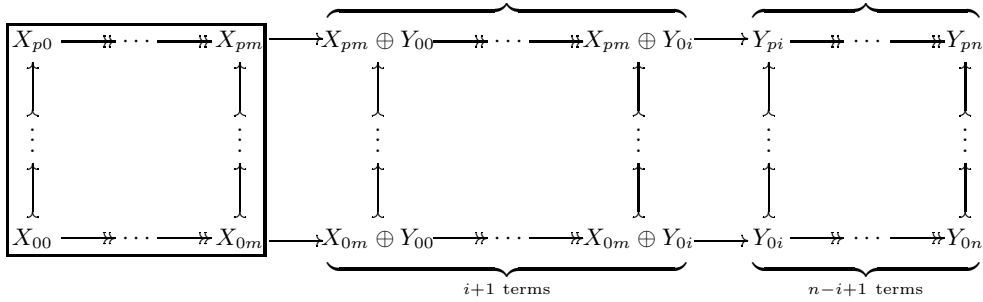

in other words, to each column of X_E 's in the homotopy we add a Y_{0i} for some i . Then it is easy to check that the horizontal maps now are admissible epi as required, so the homotopy is well defined. We denote this all-important homotopy by the shorthand symbol

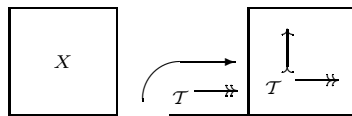

The idea of the shorthand is that somehow everything in the part of the simplex which the homotopy changes, is determined by adding X_E to Y_S , the south (= bottom) part of the array of Y 's. This homotopy connects the identity to a map whose shorthand would be written

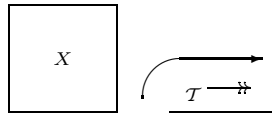

and the map is really determined by the Y_S . Another way of saying this is that the homotopy allows us to factor the identity on the Segal fiber

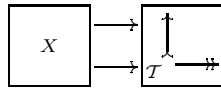

through the simplicial set

$$\underline{\mathcal{T} \twoheadrightarrow \ast}$$

which is a complicated way of denoting the nerve of the category of epimorphisms in \mathcal{T} . An n -simplex is a diagram

$$Y_0 \twoheadrightarrow \cdots \twoheadrightarrow Y_n$$

This category is contracted by the contraction to the terminal object.

2. The loop space following Gillet–Grayson. Let \mathcal{T} be an exact category (resp. a triangulated category). The Q -construction $Q(\mathcal{T})$ on the exact category \mathcal{T} (resp. a delooping of the K -theory of the triangulated

category \mathcal{T}) is homotopy equivalent to the simplicial set $\square_{\mathcal{T}}$. Then we

prove:

LEMMA 2.1. *The simplicial set*

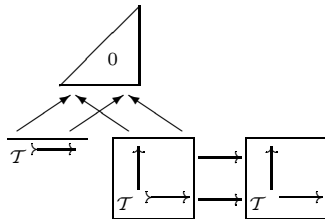

is contractible.

REMARK 2.2. The simplicial set in Lemma 2.1 deserves some explanation. A simplex is a pair of diagrams

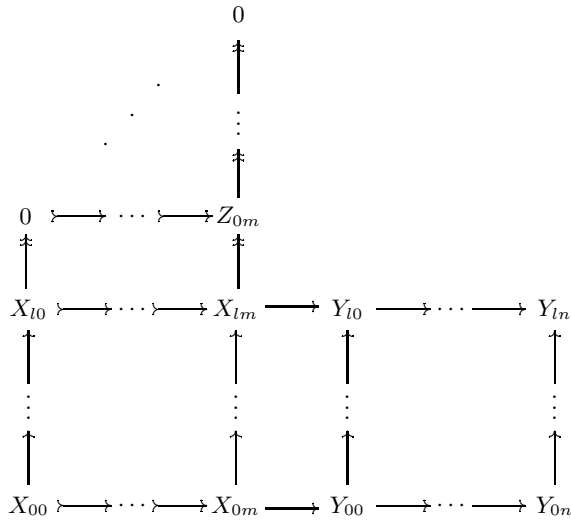

and

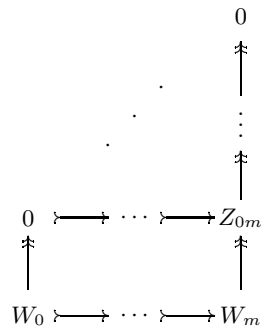

where, in the case where \mathcal{T} is exact, all squares are bicartesian, and in the case where \mathcal{T} is triangulated they all fold to give semi-triangles. In the case where \mathcal{T} is exact, the restrictions on the morphisms are as shown; some are restricted to be epi, others mono. In the case of a triangulated category \mathcal{T} , there are no restrictions.

Proof of Lemma 2.1. The projection

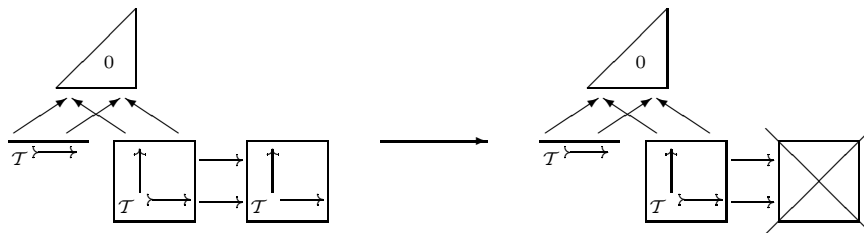

induces a homotopy equivalence, as the Segal fiber

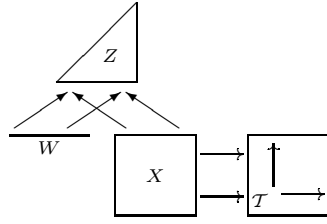

is contracted by the homotopy

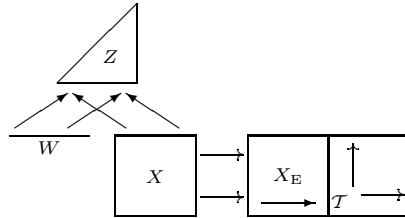

Next, the projection

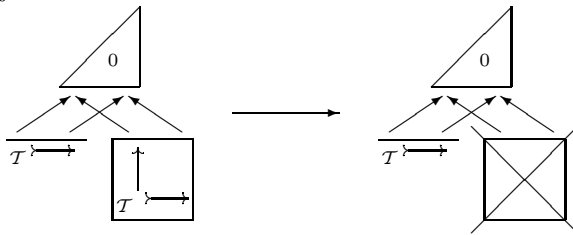

also induces a homotopy equivalence, as the Segal fiber

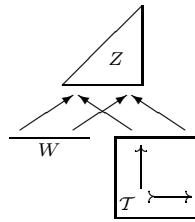

is contracted by the homotopy

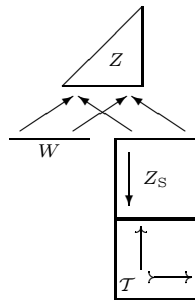

Finally, the simplicial set

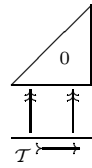

is clearly contractible, by the contraction to the initial object. ■

THEOREM 2.3. *The natural projection*

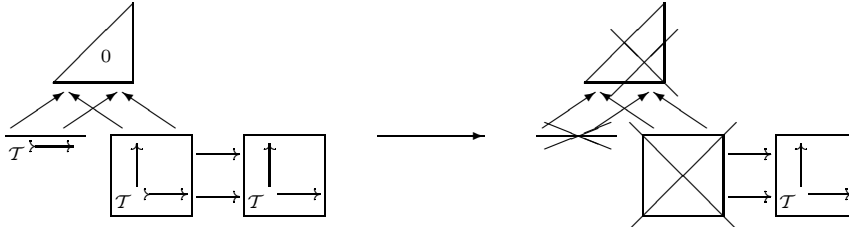

induces a quasi-fibration.

Proof. It suffices to show that the Segal fibers

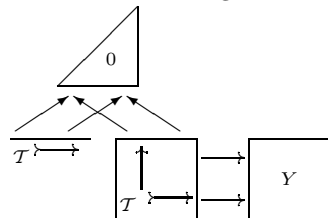

have a homotopy type independent of Y , and that the face maps on Y , in both simplicial directions, induce homotopy equivalences. The fact that this suffices is essentially Quillen's Theorem B. See the Lemma at the top of page 98 in [12]. But the homotopy

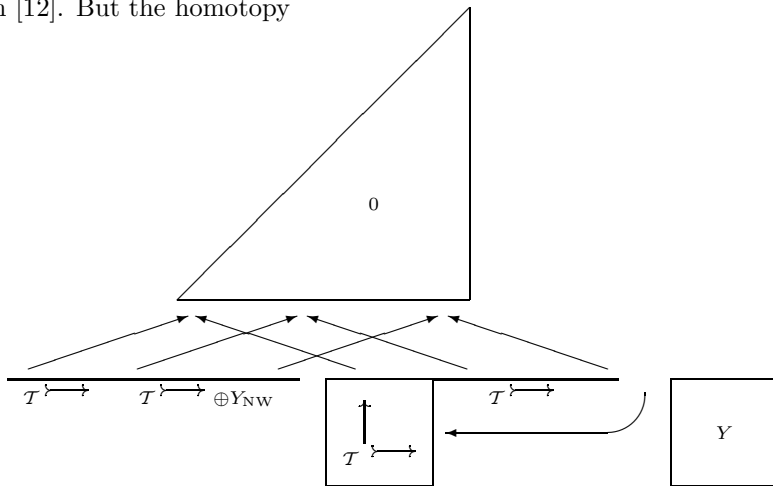

allows us to factor the identity, up to homotopy, through the simplicial set

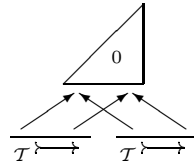

Note for the reader unfamiliar with the shorthand. The homotopy whose shorthand is the curious symbol above is the following. A simplex in the Segal fiber

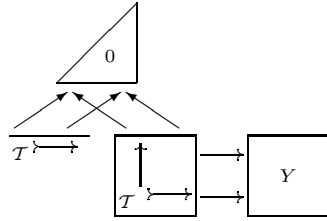

is a pair of diagrams

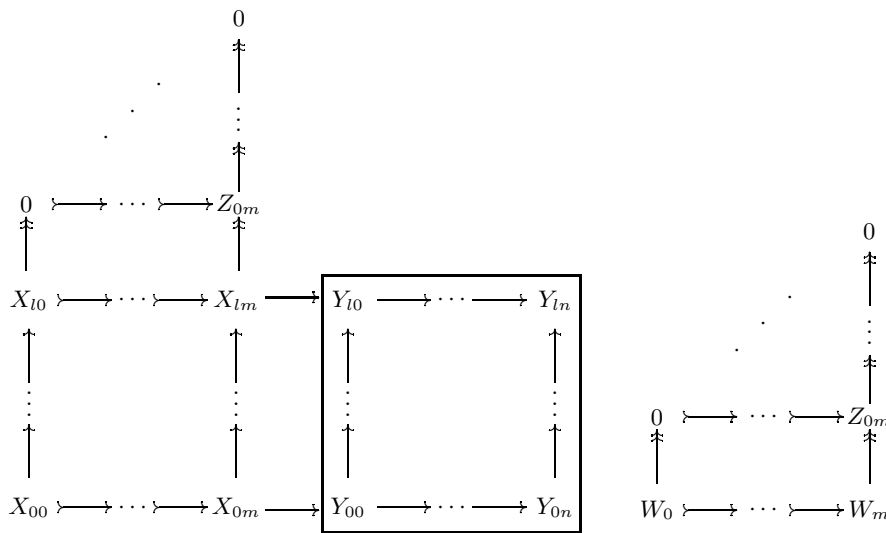

There is only one simplicial structure being realised, the one corresponding to varying the integer m . The homotopy takes the above simplex to a string of $m + 1$ different $(m + 1)$ -simplices, the i th of which is given by the pair of diagrams

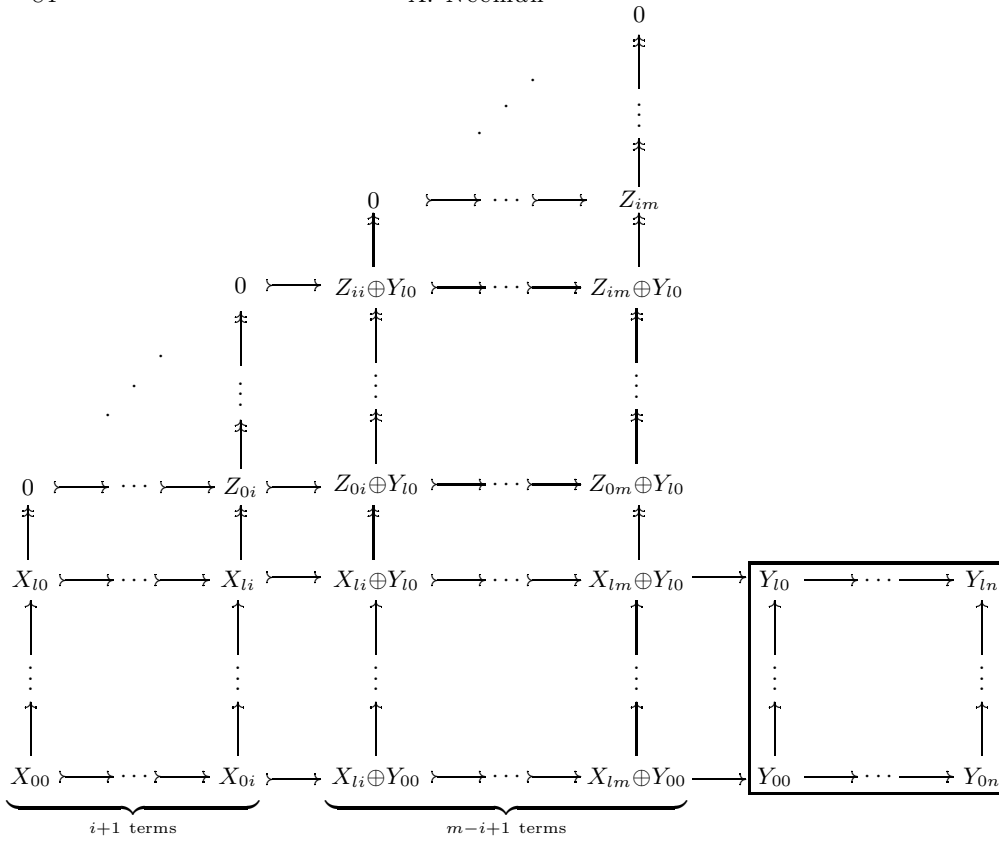

and

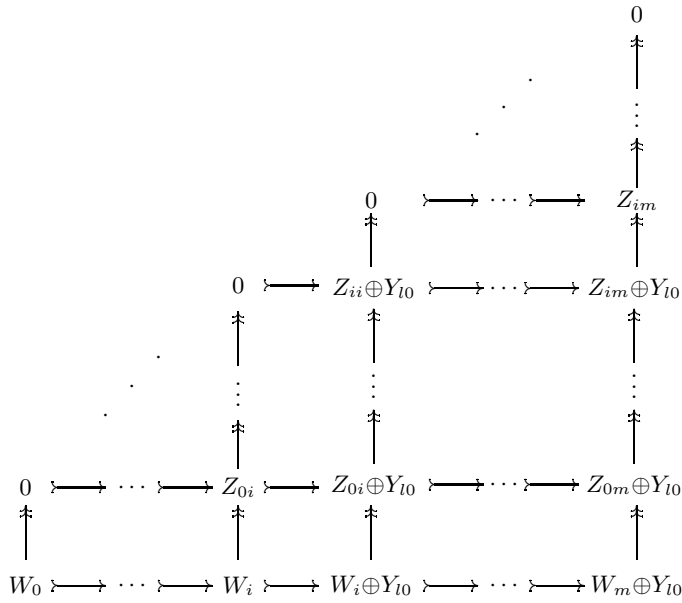

We usually denote Y_{l_0} by Y_{NW} , to indicate that it is the north-west corner of the Y box. With this notation, the homotopy connects the identity to the map taking our simplex to the pair of diagrams

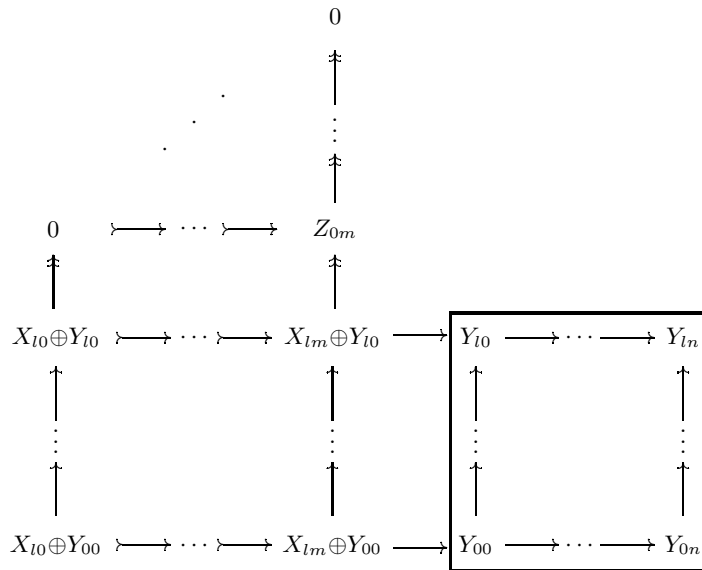

and

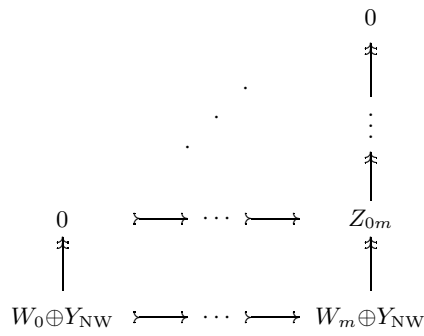

Now, define two maps

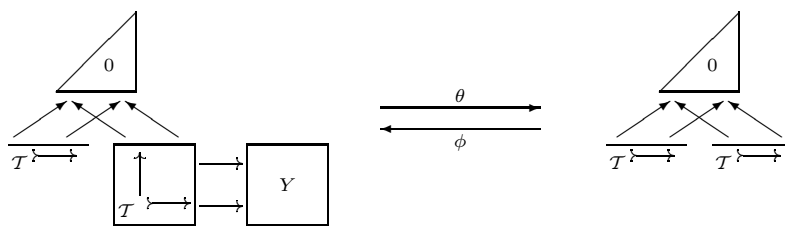

as follows. Let θ take the simplex given by the pair of diagrams

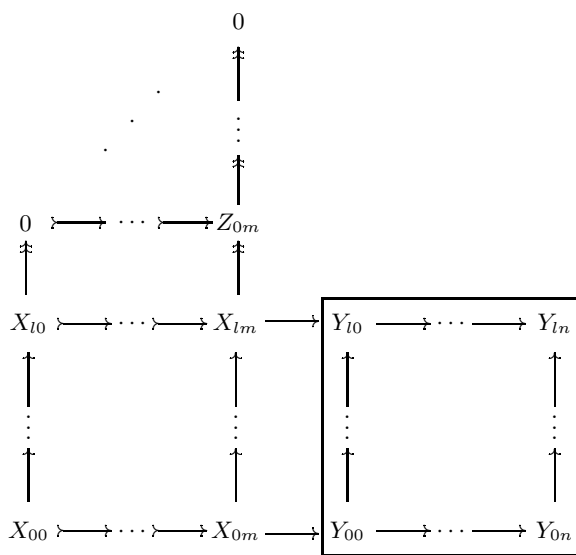

and

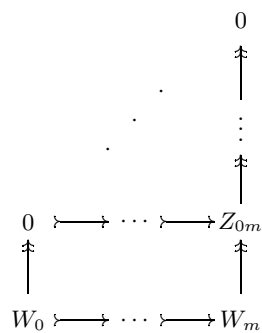

to the pair of diagrams

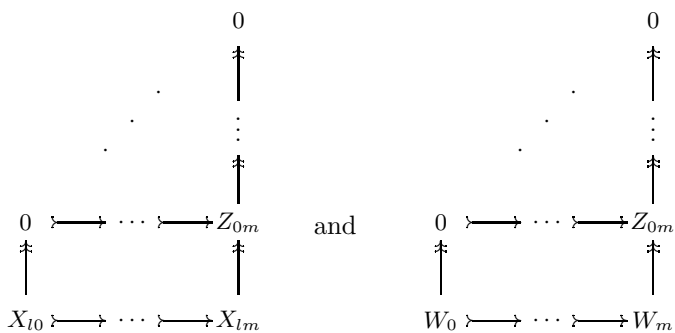

and define ϕ to be the map taking the simplex given by the pair of diagrams

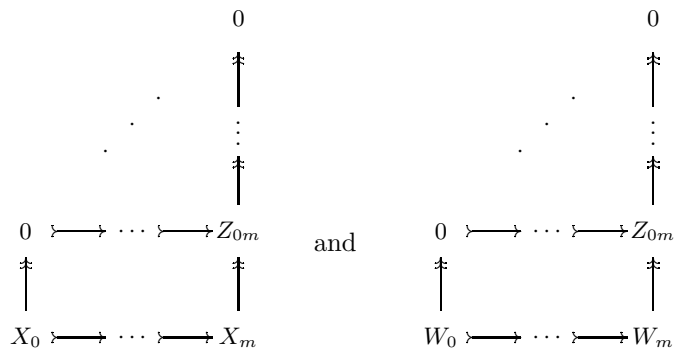

to the simplex given by the pair of diagrams

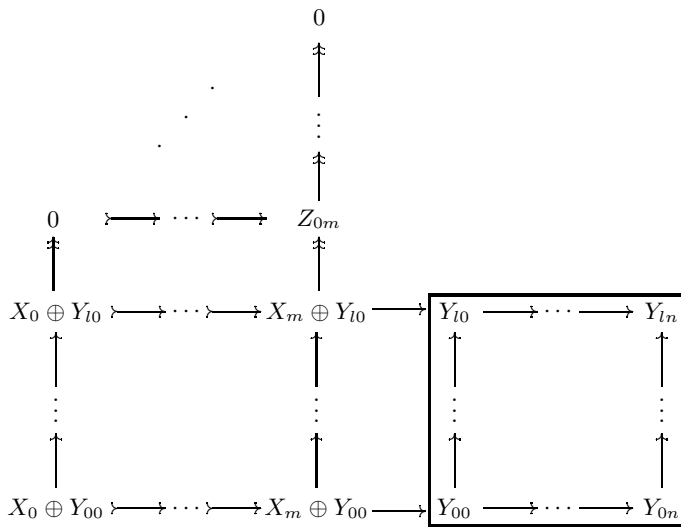

and

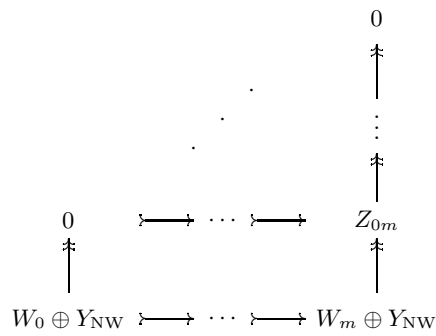

The homotopy with the funny symbol above connects the identity on the Segal fiber to the composite $\phi \circ \theta$; we have just shown that $\phi \circ \theta$ is homotopic

to the identity. But $\begin{array}{c} \triangle \\ \text{0} \\ \swarrow \quad \searrow \\ \overline{\mathcal{T}} \rightrightarrows \quad \overline{\mathcal{T}} \rightrightarrows \end{array}$ is an H -space, with the addition being direct sum. And $\theta \circ \phi$ is just translation in the H -space structure by the 0-cell

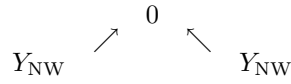

and this 0-cell is clearly in the component of the identity; thus ϕ and θ are homotopy inverses to each other. But now for any face map ∂ on Y , there is a diagram

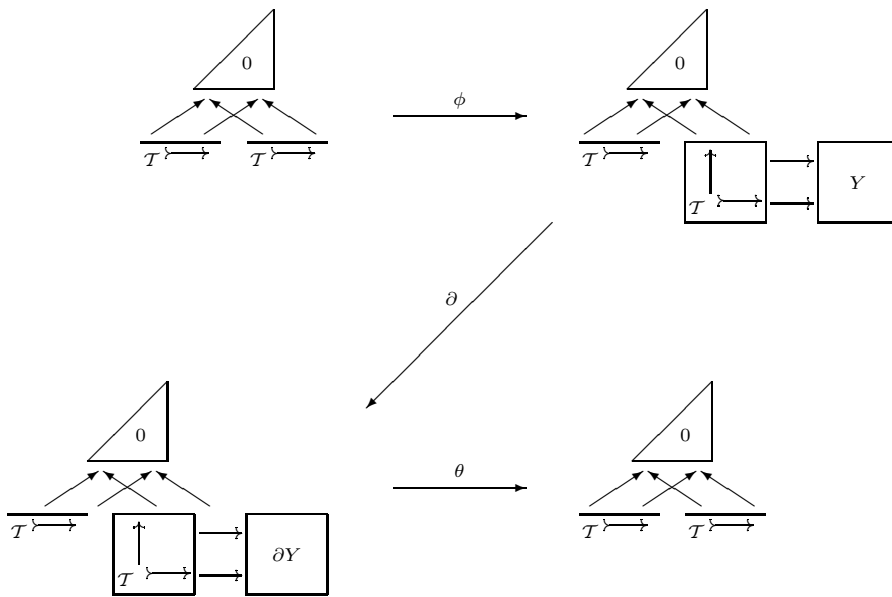

and the composite $\theta \circ \partial \circ \phi$ is easily computed to be translation in the H -space

structure of $\begin{array}{c} \triangle \\ \text{0} \\ \swarrow \quad \searrow \\ \overline{\mathcal{T}} \rightrightarrows \quad \overline{\mathcal{T}} \rightrightarrows \end{array}$ with respect to the 0-cell

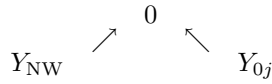

for some j . But then the homotopy inverse of $\theta \circ \partial \circ \phi$ is translation by the 0-cell

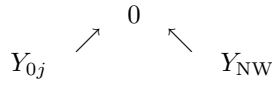

and it immediately follows that $\theta \circ \partial \circ \phi$ is a homotopy equivalence, and hence so also is ∂ . ■

COROLLARY 2.4. *The simplicial set*

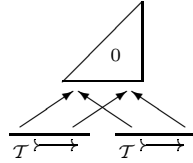

is a simplicial model for the loop space of the Q -construction. ■

REMARK 2.5. In the case where \mathcal{T} is an exact category, Corollary 2.4 is due to Gillet–Grayson [3]. For the case where \mathcal{T} is triangulated, the result is new.

3. The loop space following Giffen. The theorem of Giffen is slightly more delicate than the the result of Gillet and Grayson. The problem is that the cases of exact and triangulated categories are not precisely parallel. I will prove the theorem in the triangulated setting (which is easier), and occasionally make remarks about the modifications needed in the case of exact categories.

Let \mathcal{T} be a triangulated category. (It may also be permitted to be an exact category, but then extra care is required.)

LEMMA 3.1. *The simplicial set*

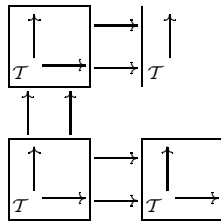

is contractible.

Proof. Consider the diagram

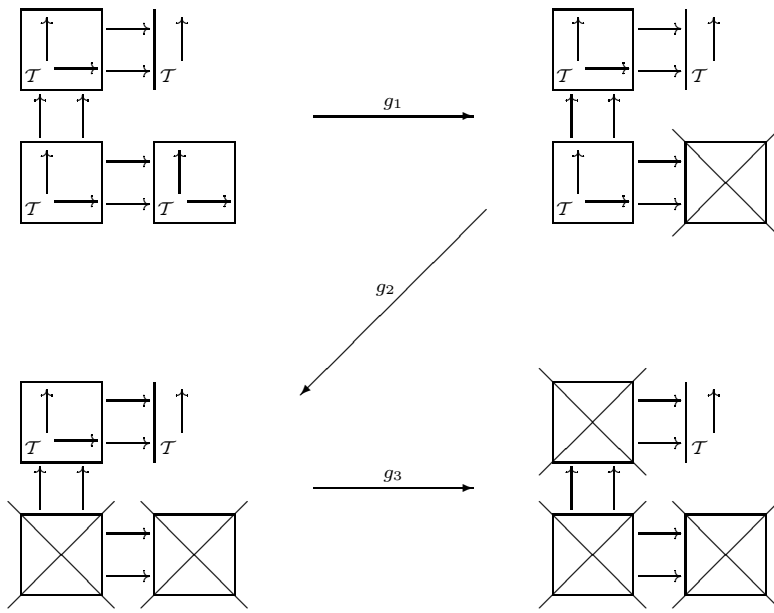

The maps g_1 , g_2 and g_3 are homotopy equivalences, since in each case the Segal fiber is clearly contractible. But the codomain of g_3 is the nerve of the category \mathcal{T} , which is contractible because it has a zero object (both initial and terminal). ■

THEOREM 3.2. *The simplicial map*

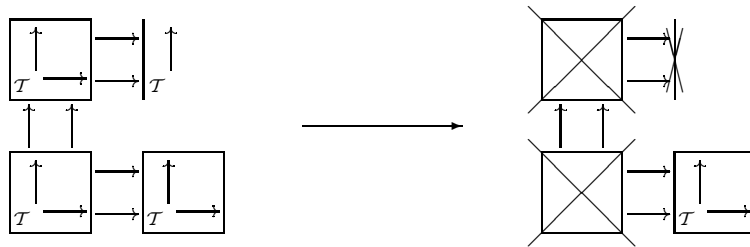

induces a quasi-fibration.

Proof. We study the Segal fiber

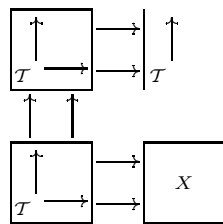

The homotopy

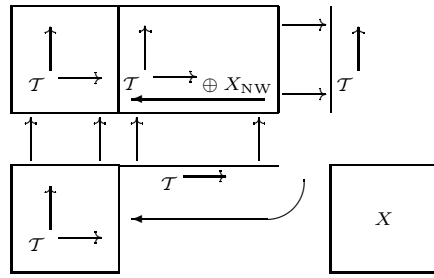

can be followed by the homotopy

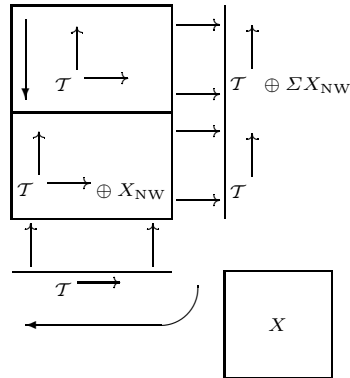

where ΣX_{NW} is the suspension of the object X_{NW} . (This, of course, only makes sense for triangulated categories. We will discuss what to do about exact categories in Remark 3.3.) Then we have a factoring of the identity on the Segal fiber. Precisely, we have maps

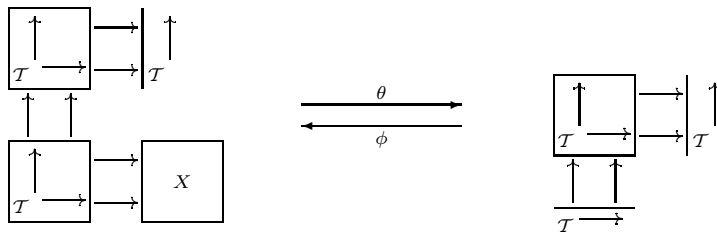

and we have just shown that $\phi \circ \theta$ is homotopic to the identity. But

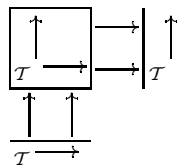

is an H -space, with the operation being direct sum. And $\theta \circ \phi$ is just translation in the H -space structure by the 0-cell

$$\begin{array}{c} 0 \\ \uparrow \\ X_{\text{NW}} \end{array} \rightarrow \Sigma X_{\text{NW}}$$

which is in the connected component of the identity. This means that ϕ and θ are homotopy inverses. But we have a diagram

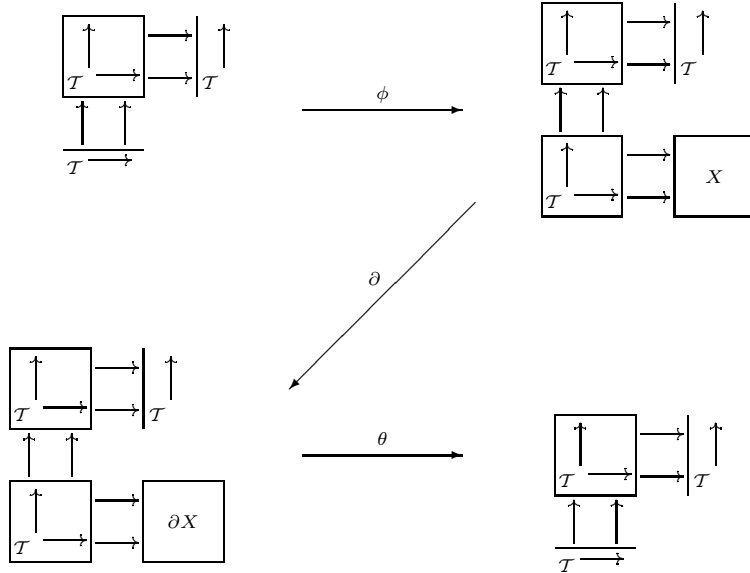

It gives a composite $\theta \circ \partial \circ \phi$, which is easily computed to be translation in

the H -space structure of $\begin{array}{c} \square \\ \uparrow \uparrow \\ T \end{array}$ with respect to the 0-cell

$$\begin{array}{c} 0 \\ \uparrow \\ X_{ij} \end{array} \rightarrow \Sigma X_{\text{NW}}$$

for some i, j . But then the homotopy inverse of $\theta \circ \partial \circ \phi$ is translation by the 0-cell

$$\begin{array}{c} 0 \\ \uparrow \\ X_{\text{NW}} \end{array} \rightarrow \Sigma X_{ij}$$

and it immediately follows that $\theta \circ \partial \circ \phi$ is a homotopy equivalence, and hence so also is ∂ . ■

REMARK 3.3. The case where \mathcal{T} is an exact category is not quite the same; the object ΣX_{NW} does not make sense, and hence neither does the homotopy

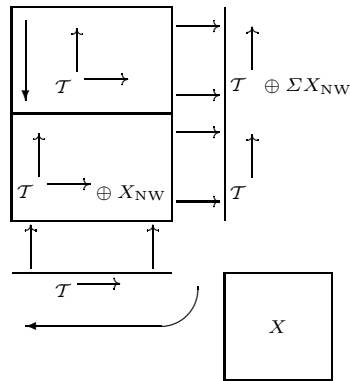

To get around this problem one considers two homotopies,

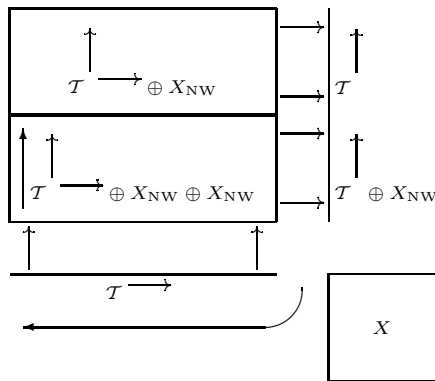

followed by

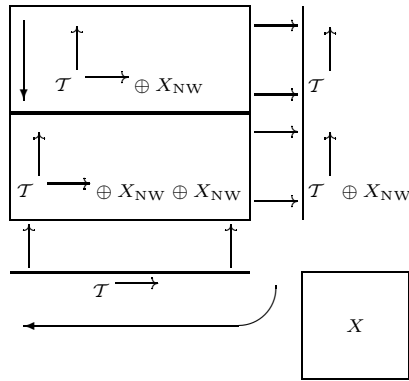

With an astute choice of the maps from the bottom right hand to the objects X_{NW} in the boxes above, one can arrange that the final map

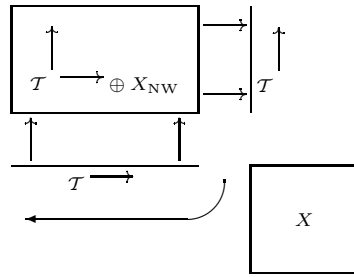

does indeed factor as a composite

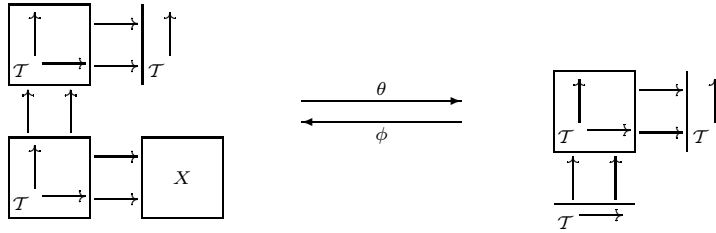

Beyond this, the argument is essentially identical with the proof of Theorem 3.2, but with slightly different 0-cells.

COROLLARY 3.4. *The simplicial set*

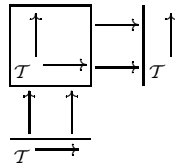

is a model for the loop space of \mathcal{T} .

REMARK 3.5. In the case where \mathcal{T} is an exact category, Corollary 3.4 is more or less due to Giffen [1]. For the case where \mathcal{T} is triangulated, Corollary 3.4 is new.

I should explain what I mean by saying the Corollary is “more or less” due to Giffen. The difference between Corollary 3.4 and the result in Giffen’s [1] is in the precise restrictions on the horizontal and vertical morphisms. What is really clear is that Giffen’s K -construction agrees with the diagonal realisation of

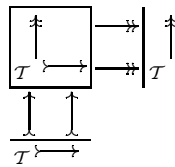

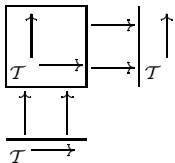
This is not quite the same as  ; there are restrictions on the

morphisms to be epi or mono. But as we learned in Theorem I.3.7 of [7], or rather in the proof of the theorem, this is a minor point. The inclusion

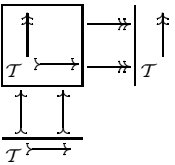
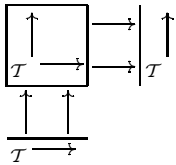
of  into  is easily shown to be a homotopy

equivalence.

References

- [1] C. H. Giffen, *Loop spaces for the Q -construction*, J. Pure Appl. Algebra 52 (1988), 1–30.
- [2] —, *Unitary algebraic Witt- and K -theories*, preprint.
- [3] H. Gillet and D. R. Grayson, *The loop space of the Q -construction*, Illinois J. Math. 31 (1987), 574–597.
- [4] D. R. Grayson, *Higher algebraic K -theory II (after D. Quillen)*, in: Algebraic K -Theory, Lecture Notes in Math. 551, Springer, 1976, 217–240.
- [5] —, *Exterior power operations on higher K -theory*, K -Theory 3 (1989), 247–260.
- [6] J. F. Jardine, *The multiple Q -construction*, Canad. J. Math. 39 (1987), 1174–1209.
- [7] A. Neeman, *K -theory for triangulated categories $I(A)$* , Asian J. Math. 1 (1997), 330–417.
- [8] —, *K -theory for triangulated categories $I(B)$* , *ibid.* 1 (1997), 435–529.
- [9] —, *K -theory for triangulated categories II* , *ibid.* 2 (1998), 1–125.
- [10] —, *K -theory for triangulated categories $III(A)$* , *ibid.* 2 (1998), 495–594.
- [11] —, *K -theory for triangulated categories $III(B)$* , *ibid.* 3 (1999), 555–606.
- [12] D. Quillen, *Higher algebraic K -theory I*, in: Algebraic K -Theory I, Lecture Notes in Math. 341, Springer, 1973, 85–147.
- [13] G. Segal, *Categories and cohomology theories*, Topology 13 (1974), 293–312.

Centre for Mathematics and its Applications
 The Australian National University
 Canberra, ACT 0200, Australia
 E-mail: amnon.neeman@anu.edu.au

*Received 23 November 1999;
 in revised form 19 January 2000*